

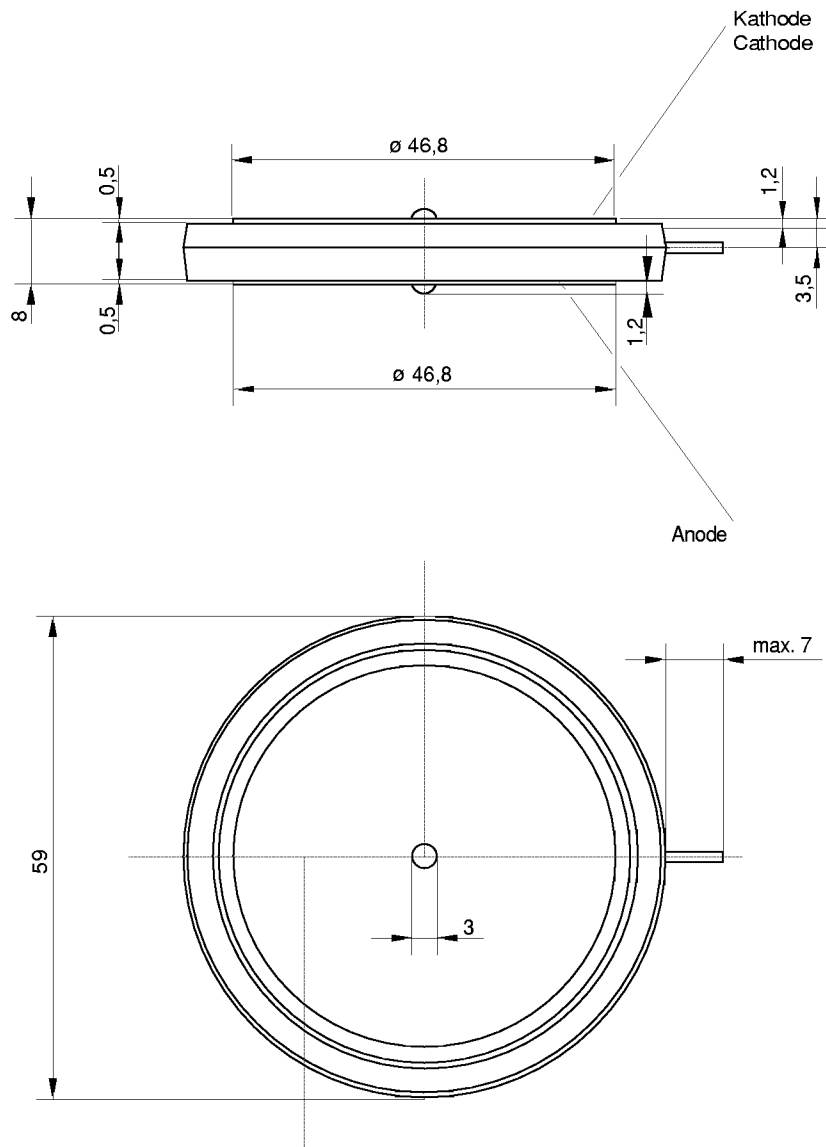

European Power-Semiconductor and Electronics Company GmbH + Co. KG

Leistungsgleichrichterdioden Power Rectifier Diodes D 4457 N



D 4457 N

Elektrische Eigenschaften

Electrical properties

Höchstzulässige Werte

Maximum rated values

Periodische Spitzensperrspannung	repetitive peak reverse voltage	$t_{vj} = -40^{\circ}\text{C} \dots t_{vj \max}$	V_{RRM}	200, 400	V
				600	V
Stoßspitzensperrspannung	non-repetitive peak reverse voltage	$t_{vj} = +25^{\circ}\text{C} \dots t_{vj \max}$	$V_{RSM} = V_{RRM}$	+ 50	V
Durchlaßstrom-Grenzeffektivwert	RMS forward current		I_{FRMSM}	7	kA
Dauergrenzstrom	mean forward current	$t_c = 111^{\circ}\text{C}$	I_{FAVM}	4,46	kA
		$t_c = 130^{\circ}\text{C}$		3,52	kA
Stoßstrom-Grenzwert	surge forward current	$t_{vj} = 25^{\circ}\text{C}, t_p = 10 \text{ ms}$	I_{FSM}	60	kA
		$t_{vj} = t_{vj \max}, t_p = 10 \text{ ms}$		52	kA
Grenzlastintegral	$I^2 t$ -value	$t_{vj} = 25^{\circ}\text{C}, t_p = 10 \text{ ms}$	$I^2 t$	180	kA^2s
		$t_{vj} = t_{vj \max}, t_p = 10 \text{ ms}$		135	kA^2s

Charakteristische Werte

Characteristic values

Durchlaßspannung	on-state voltage	$t_{vj} = t_{vj \max}, I_F = 14 \text{ kA}$	V_T	max.	1,36	V
Schleusenspannung	threshold voltage	$t_{vj} = t_{vj \max}$	$V_{T(TO)}$		0,7	V
Ersatzwiderstand	slope resistance	$t_{vj} = t_{vj \max}$	r_T		0,047	$\text{m}\Omega$
Sperrstrom	reverse current	$t_{vj} = t_{vj \max}, V_R = V_{RRM}$	I_R	max.	60	mA

Thermische Eigenschaften

Thermal properties

Innerer Widerstand	thermal resistance, junction to case	beidseitig/two-sided, $\Theta = 180^{\circ} \sin$	R_{thJC}	max.	0,0128	$^{\circ}\text{C/W}$
		beidseitig/two sided, DC		max.	0,0120	$^{\circ}\text{C/W}$
		Anode/anode, $\Theta = 180^{\circ} \sin$		max.	0,0208	$^{\circ}\text{C/W}$
		Anode/anode, DC		max.	0,0200	$^{\circ}\text{C/W}$
		Kathode/cathode, $\Theta = 180^{\circ} \sin$		max.	0,0308	$^{\circ}\text{C/W}$
		Kathode/cathode, DC		max.	0,0300	$^{\circ}\text{C/W}$
Übergangs-Wärmewiderstand	thermal resistance, case to heatsink	beidseitig /two-sided	R_{thCK}	max.	0,003	$^{\circ}\text{C/W}$
		einseitig /single-sided		max.	0,006	$^{\circ}\text{C/W}$
Höchstzul. Sperrschichttemperatur	max. junction temperature		$t_{vj \max}$		180	$^{\circ}\text{C}$
Betriebstemperatur	operating temperature		$t_{c \text{ op}}$		-40...+150	$^{\circ}\text{C}$
Lagertemperatur	storage temperature		t_{stg}		-40...+150	$^{\circ}\text{C}$

Mechanische Eigenschaften

Mechanical properties

Si-Element mit Druckkontakt	Si-pellet with pressure contact	$\varnothing = 46 \text{ mm}$				
Anpreßkraft	clamping force	Gehäuseform/case design T	F		30...45	kN
Gewicht	weight		G	typ.	125	g
Kriechstrecke	creepage distance				5,5	mm
Feuchteklasse	humidity classification	DIN 40040				C
Schwingfestigkeit	vibration resistance	$f = 50 \text{ Hz}$			50	m/s^2
Maßbild	outline					Seite/page

D 4457 N

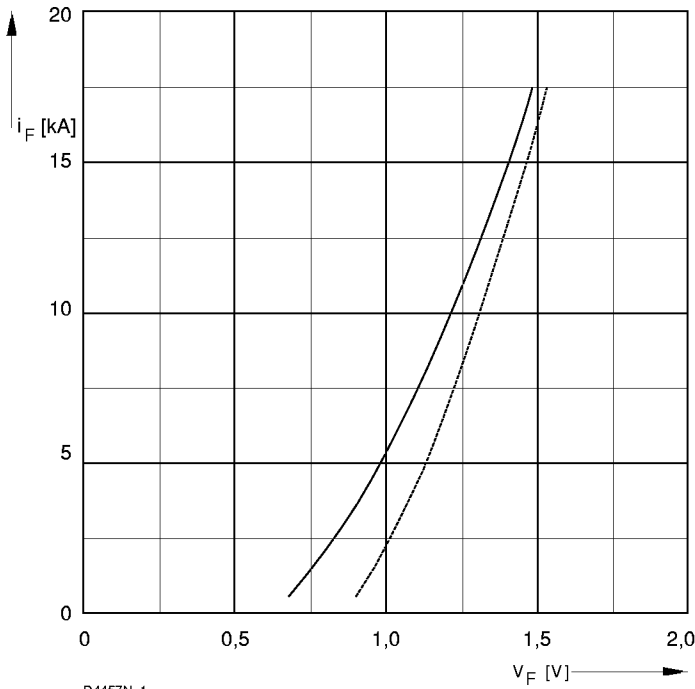

D4457N_1

Bild/ Fig. 1

Grenzdurchlaßkennlinie

Limiting forward characteristic $i_F = f(V_F)$

— $t_{vj} = 25\text{ °C}$

- - - $t_{vj} = 25\text{ °C}$

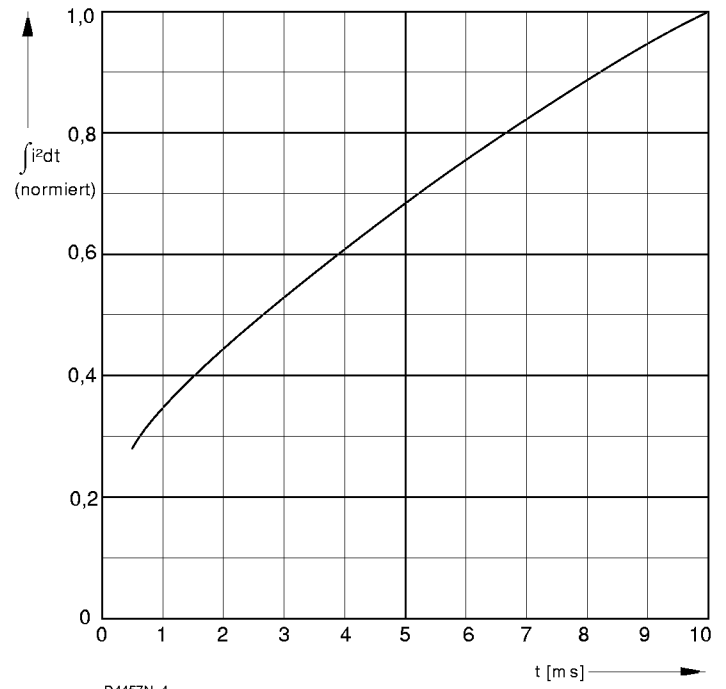

D4457N_4

Bild / Fig. 2

Normiertes Grenzlastintegral / Normalized i^2t

$\int i^2 dt = f(t_p)$

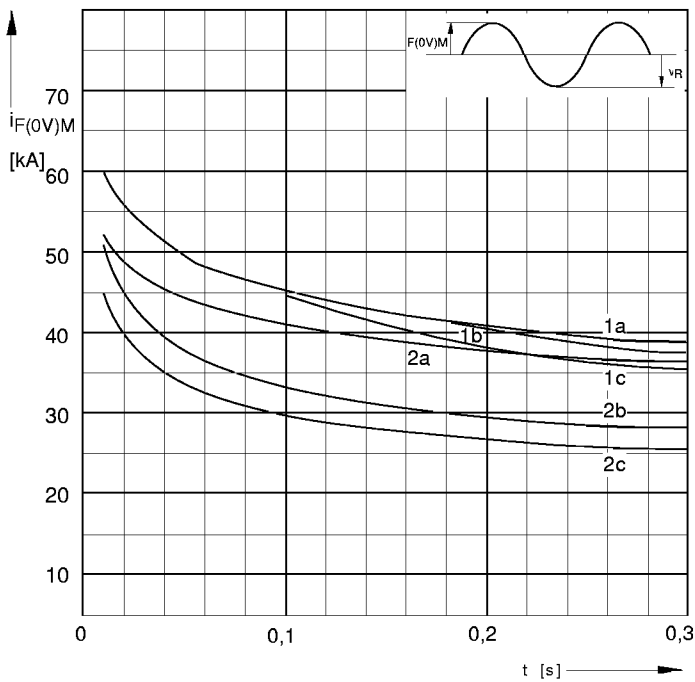

D4457N_5

Bild / Fig. 3

Grenzstrom / Maximum overload forward current $I_{F(0V)M} = f(t)$

1 - $I_{FAV(vor)} = 0\text{ A}$; $t_{vj} = t_c = 25\text{ °C}$

2 - $I_{FAV(vor)} = 1\text{ A}$; $t_c = 25\text{ °C}$; $t_{vj} = 25\text{ °C}$

a - $V_R \leq 50\text{ V}$

b - $V_R = V_{RRM}$

c - $V_R = 0,8 V_{RRM}$

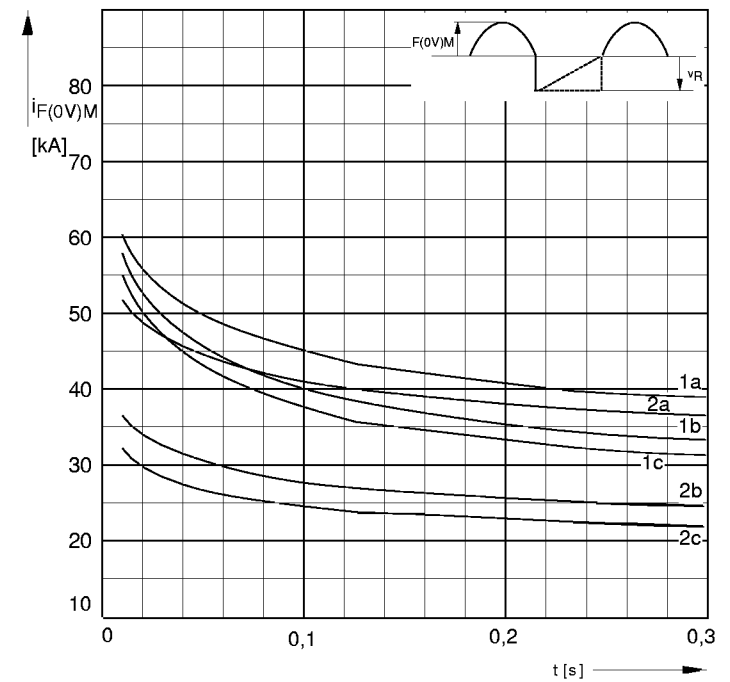

D4457_6

Bild / Fig. 4

Grenzstrom / Maximum overload forward current $I_{F(0V)M} = f(t)$

1 - $I_{FAV(vor)} = 0\text{ A}$; $t_{vj} = t_c = 25\text{ °C}$

2 - $I_{FAV(vor)} = 1\text{ A}$; $t_c = 25\text{ °C}$; $t_{vj} = 25\text{ °C}$

a - $V_R \leq 50\text{ V}$

b - $V_R = 0,5 V_{RRM}$

c - $V_R = 0,8 V_{RRM}$

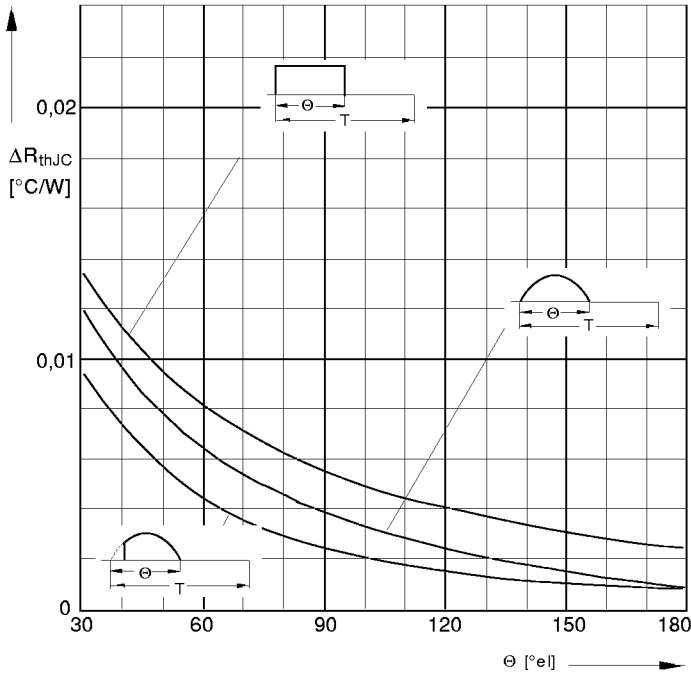

D4457N_3

Bild / Fig. 5
 Differenz zwischen den Wärmewiderständen für Pulsstrom und DC
 Difference between the values of thermal resistance for pulse current and DC
 Parameter: Stromkurvenform / Current waveform

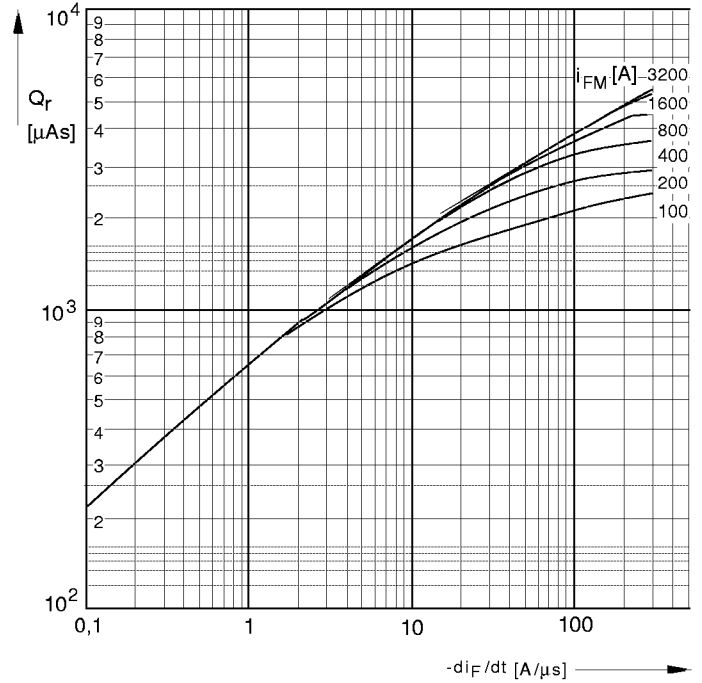

D4457N_7

Bild / Fig. 6
 Sperrverzögerungsladung / Recovered charge $Q_r = f(-di/dt)$
 $t_{vj} = t_{vjmax}$; $V_R \leq 0,5 V_{RRM}$; $V_{RM} = 0,8 V_{RRM}$
 Beschaltung / Snubber: $C = \mu F$; $R = \Omega$
 Parameter: Durchlaßstrom / Forward current I_{FM}

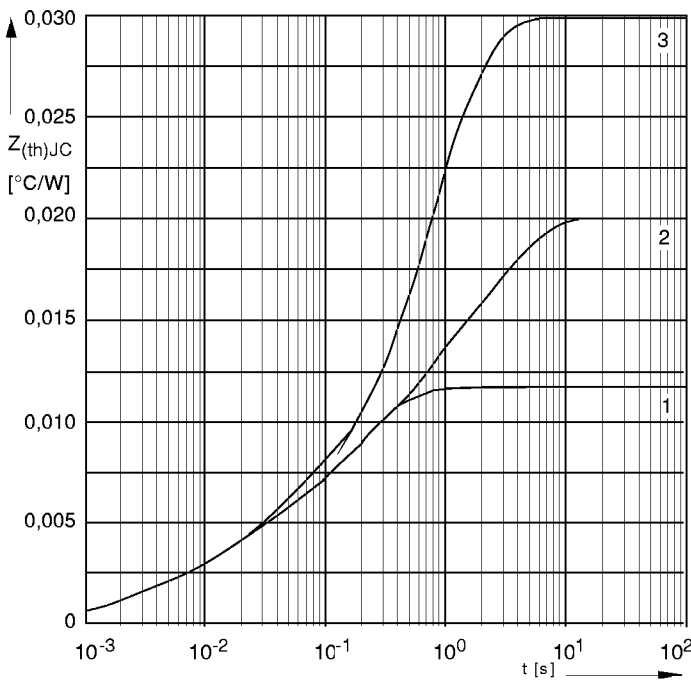

D4457N_2

Bild / Fig. 7
 Transienter innerer Wärmewiderstand
 Transient thermal impedance $Z_{thJC} = f(t)$, DC
 1 - Beidseitige Kühlung / Two-sided cooling
 2 - Anodenseitige Kühlung / Anode-sided cooling
 3 - Kathodenseitige Kühlung / Kathode-sided cooling

Analytische Elemente des transienten Wärmewiderstandes Z_{thJC} für DC
 Analytical elements of transient thermal impedance Z_{thJC} for DC

Pos. n	1	2	3	4	5	6	7
R_{thn} °C/W	0,000114	0,003146	0,00934	0,0242	0,0762	0,195	0,112
τ_n [s]	0,000018	0,000282	0,00282	0,0132	0,265	1,2	7,57

Analytische Funktion / Analytical function:

$$Z_{thJC} = \sum_{n=1}^{n_{max}} R_{thn} (1 - \text{EXP}(-t/\tau_n))$$